

Solenoid directional valves type DHI and DHU

direct operated, ISO 4401 size 06

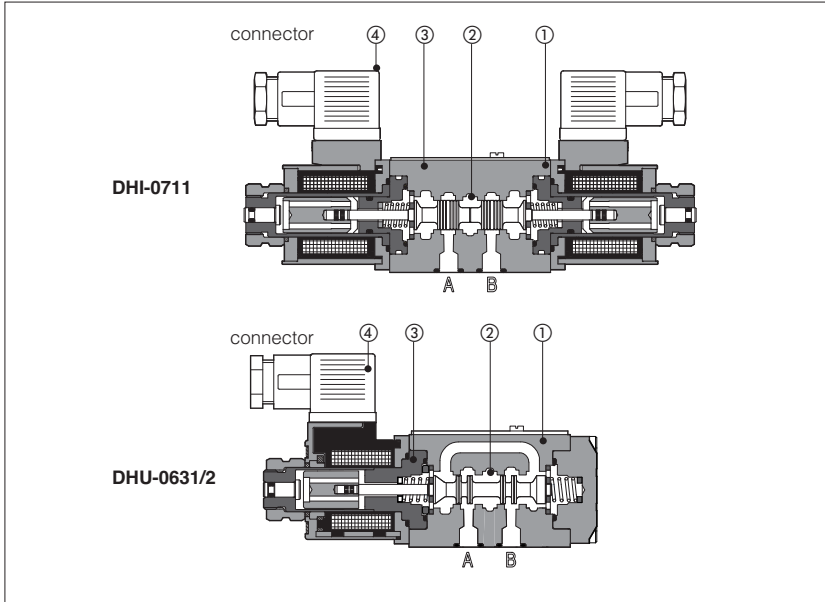

DHI and DHU are spool type, three or four way, two or three position direct operated solenoid valves designed to operate in oil hydraulic systems.

They are operated by wet and pressure sealed solenoid ③ with manual override and with coils certified according the North American standard **cURus**:

- **DHI** for AC and DC supply;
- **DHU** for DC supply with improved performances.

Moving parts are protected, lubricated and cushioned in oil.

Shell-moulding casting ① machined by transfer lines and then cleaned by thermal deburring.

Optimized flow paths largely cored with extrawide channels to tank for low pressure drops.

Interchangeable spools ② available in a wide variety of configurations.

DHU valves can be supplied with optional devices for control of switching times.

Standard electric/electronic connectors ④ able to satisfy the requirements of modern machines for electric interfaces characteristics.

Coils are fully encapsulated (class H) and are easily replaceable without aid of tools.

Rugged execution suitable for outdoor use.

Surface mounting ISO 4401 size 06.

Max flow up to 60 l/min.

Max pressure: 350 bar.

1 MODEL CODE	DHI	-	0	63	1/2	/A - X	24 DC	**	/*
Directional control valves size 06 DHI-0 = AC and DC supply DHU-0 = for DC supply									Synthetic fluids WG = water glycol PE = phosphate ester
Valve configuration, see table 2 61 = single solenoid, center plus external position, spring centered 63 = single solenoid, 2 external positions, spring offset 67 = single solenoid, center plus external position, spring offset 70 = double solenoid, 2 external positions, without springs 71 = double solenoid, 3 positions, spring centered 75 = double solenoid, 2 external positions, with detent 77 = double solenoid, center plus external position, without springs Other configurations are available on request.								Series number	
Spool type, see table 3.								Voltage code, see section 5 00 = valve without coils	
Options, see note 1 at section 5.								X = without connector See note 2 at section 5 for available connectors, to be ordered separately Coils with special connectors, see section 10 XJ = AMP Junior Timer connector XK = Deutsch connector XS = Lead Wire connection	
Note: configuration 63 and 70 are available only with spools type 0/2, 1/2 and 2/2. configuration 75 is available only with spools type 0/2 and 1/2.									

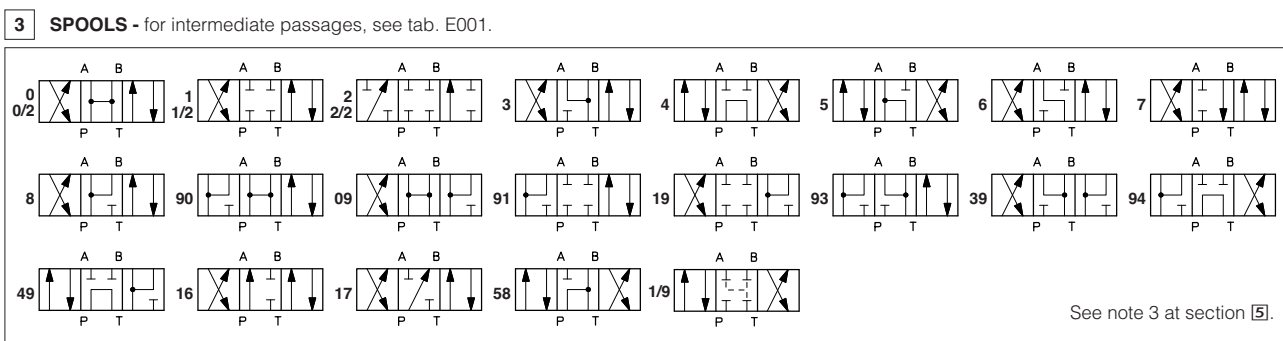
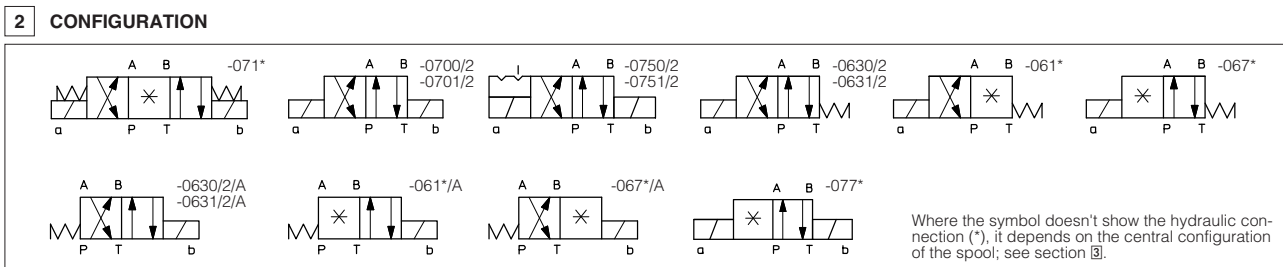

4 MAIN CHARACTERISTICS OF DHI AND DHU DIRECTIONAL VALVES

Assembly position / location	Any position for all valves except for type - 070* (without springs) that must be installed with horizontal axis if operated by impulses	
Subplate surface finishing	Roughness index \sqrt{Ra} flatness ratio 0,01/100 (ISO 1101)	
Ambient temperature	from -20°C to +70°C	
Fluid	Hydraulic oil as per DIN 51524 535; for other fluids see section 11	
Recommended viscosity	15 ÷ 100 mm ² /s at 40°C (ISO VG 15 ÷ 100)	
Fluid contamination class	ISO 19/16, achieved with in line filters at 25 µm value to $\beta_{25} \geq 75$ (recommended)	
Fluid temperature	-20°C +60°C (standard and /WG seals) -20°C +80°C (/PE seals)	
Flow direction	As shown in the symbols of tables 2 and 3	
Operating pressure For versions with proximity switches (/FI/NC and /FI/NO versions) maximum counter pressure allowed on T port is 5 bar	DHI	Ports P,A,B: 350 bar; Port T: 120 bar
	DHU	Ports P,A,B: 350 bar; Port T 210 bar
Rated flow	See diagrams Q/Δp at section 7	
Maximum flow	60 l/min see operating limits at section 8	

4.1 Coils characteristics

Insulation class	H (180°C) Due to the occurring surface temperatures of the solenoid coils, the European standards EN563 and EN982 must be taken into account
Connector protection degree DIN 43650	IP 65
Relative duty factor	100%
Supply voltage and frequency	See electric feature 6
Supply voltage tolerance	± 10%
Certification	cURus

5 NOTES

1 Options

- A** = Solenoid mounted at side of port B (only for single solenoid valves). In standard versions, solenoid is mounted at side of port A.
- WP** = prolonged manual override protected by rubber cap - see section 12.
- SP-WPD/H** = manual override with detent, to be ordered separately, see tab. K150
- L1, L2, L3** = device for switching time control, installed in the valve solenoid (only for DHU models).
For spools 4 and 4/8 only device L3 is available.
- F *** = with proximity switch for monitoring spool position: see tab. E110.
- MV, MO** = auxiliary hand lever positioned vertically (MV) or horizontally (MO). For available configuration and dimensions see table E138.

2 Type of electric/electronic connector DIN 43650, to be ordered separately

- SP-666** = standard connector IP-65, suitable for direct connection to electric supply source.
- SP-667** = as SP-666, but with built-in signal led.
- SP-669** = with built-in rectifier bridge for supplying DC coils by alternate current (AC 110V and 230V - I_{max} 1A).
- E-SD** = electronic connector which eliminates electric disturbances when solenoid valves are de-energized.

3 Spools

- spools type **0/2, 1/2, 2/2** are only used for two position valves: single solenoid, type DH*-063*/2 and double solenoid type DH*-070*/2 and DH*-075*/2 (only spools).
- spools type **0** and **3** are also available as **0/1** and **3/1** with restricted oil passages in central position, from user ports to tank.
- spools type **1, 4** and **5** are also available as **1/1, 4/8** and **5/1**. They are properly shaped to reduce water-hammer shocks during the swiching.
- spools type **1, 3, 8** and **1/2** are available as **1P, 3P, 8P** and **1/2P** to limit valve internal leakages.
- spool type **1/9** has closed center in rest position but it avoids the pressurization of A and B ports due to the internal leakages.
- Other types of spools can be supplied on request.

6 ELECTRIC FEATURES

Valve	External supply nominal voltage ± 10%	Voltage code	Type of connector	Power consumption (2)	Code of spare coil		Colour of coil label	
					DHI	DHU		
DHI DHU	6 DC	6 DC	SP-666 or SP-667	33 W	SP-COU-6DC / 80	SP-COU-6DC / 80	brown	
	9 DC	9 DC			SP-COU-9DC / 80	SP-COU-9DC / 80	light blue	
	12 DC	12 DC			SP-COU-12DC / 80	SP-COUR-12DC / 10	green	
	14 DC	14 DC			SP-COU-14DC / 80	SP-COUR-14DC / 10	brown	
	18 DC	18 DC			SP-COU-18DC / 80	SP-COU-18DC / 80	blue	
	24 DC	24 DC			SP-COU-24DC / 80	SP-COUR-24DC / 10	red	
	28 DC	28 DC			SP-COU-28DC / 80	SP-COUR-28DC / 10	silver	
	48 DC	48 DC			SP-COU-48DC / 80	SP-COU-48DC / 80	silver	
	110 DC	110 DC			SP-COU-110DC / 80	SP-COUR-110DC / 10	black	
	125 DC	125 DC			SP-COU-125DC / 80	SP-COU-125DC / 80	silver	
	220 DC	220 DC			SP-COU-220DC / 80	SP-COUR-220DC / 10	black	
	24/50 AC	24/50/60 AC			SP-669	60 VA (3)	SP-COI-24/50/60AC / 80 (1)	-
	48/50 AC		SP-COI-48/50/60AC / 80 (1)	-			white	
	110/50 AC	110/50/60 AC	SP-669	60 VA (3)	SP-COI-110/50/60AC / 80 (1)	-	yellow	
	120/60 AC				SP-COI-120/60AC / 80	-	white	
	230/50 AC	230/50/60 AC	SP-669	60 VA (3)	SP-COI-230/50/60AC / 80 (1)	-	light blue	
	230/60 AC				SP-COI-230/60AC / 80	-	silver	
	110/50 AC	110RC	SP-669	40 VA 35 VA	SP-COU-110RC / 80	SP-COUR-110RC / 10	gold	
120/60 AC	230RC				40 VA	SP-COU-230RC / 80	SP-COUR-230RC / 10	blue
230/50 AC					35 VA			
230/60 AC								

- (1) Coil can be supplied also with 60 Hz of voltage frequency: in this case the performances are reduced by 10 ÷ 15% and the power consumption is 55 VA.
- (2) Average values based on tests performed at nominal hydraulic condition and ambient/coil temperature of 20°C.
- (3) When solenoid is energized, the inrush current is approx 3 times the holding current. Inrush current values correspond to a power consumption of about 150 VA.

7 Q/ΔP DIAGRAMS based on mineral oil ISO VG 46 at 50°C

Flow direction Spool type	Flow direction				
	P→A	P→B	A→T	B→T	P→T
0	C	C	C	C	
0/2, 1, 1/2	A	A	A	A	
2, 3	A	A	C	C	
2/2, 4, 5, 9*	D	D	D	D	A
6	A	A	C	A	
7	A	A	A	C	
8	C	C	B	B	

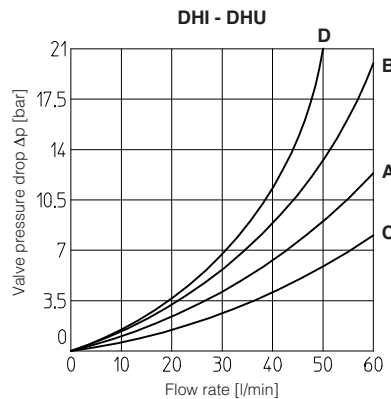

8 OPERATING LIMITS based on mineral oil ISO VG 46 at 50°C

The diagrams have been obtained with warm solenoids and power supply at lowest value ($V_{nom} = 10\%$). The curves refer to application with symmetrical flow through the valve (i.e. P→A and B→T). In case of asymmetric flow and if the valves have the devices for controlling the switching times the operating limits must be reduced.

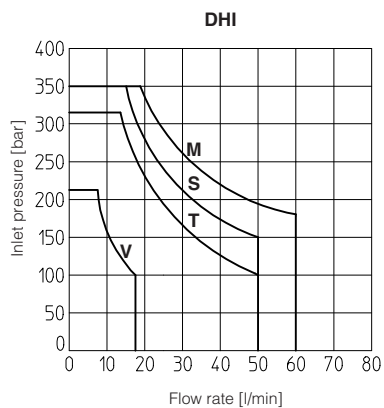

M = Spools 0, 1, 1/2, 8
S = Spools 0/2, 3, 6, 7
V = Spools 2, 2/2, *9, 9*
T = Spools 4, 5

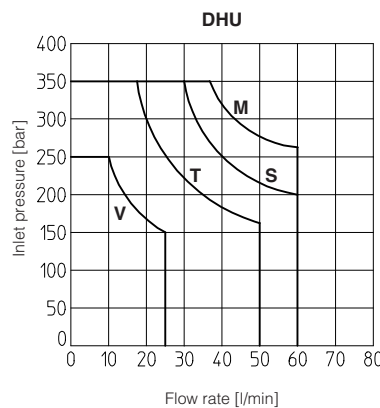

M = Spools 0, 1, 1/2, 8
S = Spools 0/2, 3, 6, 7
V = Spools 2, 2/2, *9, 9*
T = Spools 4, 5

9 SWITCHING TIMES (average values in msec)

Valve	DHI		
	Switch-on AC	Switch-on DC	Switch-off
DHI + SP-666 SP-667	30	45	20
DHI + SP-669	45	—	80
DHI + E-SD	30	45	50

Valve	DHU		
	Switch-on AC	Switch-on DC	Switch-off
DHU + SP-666 SP-667	—	45	20
DHU + SP-669	45	—	80
DHU + E-SD	—	45	50
DHU-*L1	—	60	60
DHU-*L2	—	80	80
DHU-*L3	—	110	150

Test conditions:

- 36 l/min; 150 bar
- nominal voltage
- 2 bar of counter pressure on port T
- mineral oil: ISO VG 46 at 50°C.

The elasticity of the hydraulic circuit and the variations of the hydraulic characteristics and temperature affect the response time.

10 COILS TYPE COU* and COUR* WITH SPECIAL CONNECTORS

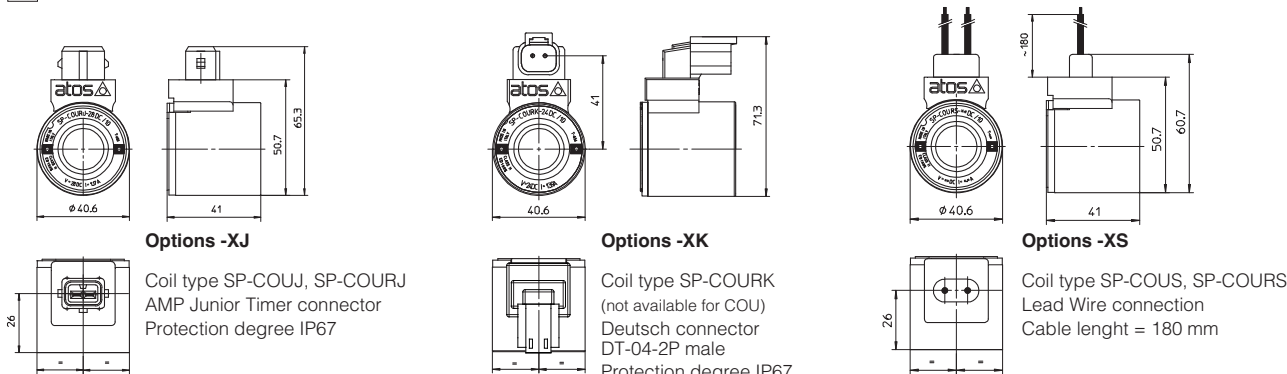

Note: The above coils are available only for voltage supply **12, 14, 24** and **28** Vdc. For the characteristics refer to standard coils features - see sect. 6

11 DIMENSIONS [mm]

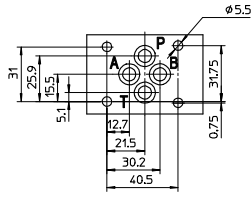

ISO 4401: 2005

Mounting surface: 4401-03-02-0-05

Fastening bolts:

4 socket head screws M5x50 class 12.9

Tightening torque = 8 Nm

Seals: 4 OR 108

Ports P,A,B,T: Ø = 7.5 mm (max).

P = PRESSURE PORT

A, B = USE PORT

T = TANK PORT

For the max pressures on ports, see section 4

DHI-06

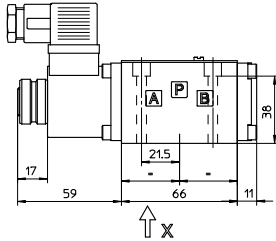

Mass: 1,5 kg

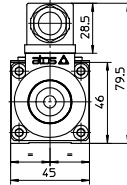

DHI-07

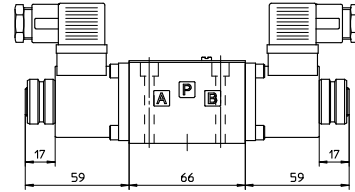

Mass: 1,8 kg

DHU-06

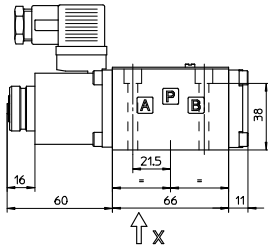

Mass: 1,5 kg

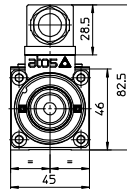

DHU-07

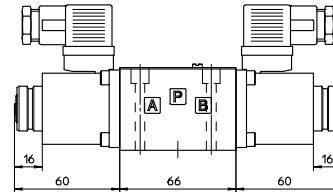

Mass: 1,8 kg

Overall dimensions refer to valves with connectors type SP-666

12 OPTION /WP

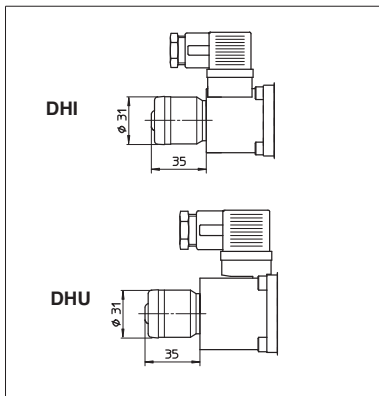

13 ELECTRIC CONNECTORS ACCORDING TO DIN 43650

The connectors must be ordered separately

SP-666, SP-667 (for AC or DC supply)		SP-669 (for AC supply)	
CONNECTOR WIRING			
<p>SP-666, SP-667</p> <p>1 = Positive ⊕ 2 = Negative ⊖ ⊕ = Coil ground</p>		<p>SP-669</p> <p>1,2 = Supply voltage Vac 3 = Coil ground</p>	
SUPPLY VOLTAGES			
<p>SP-666</p> <p>All voltages</p>	<p>SP-667</p> <p>24 AC or DC 110 AC or DC 220 AC or DC</p>	<p>110/50 AC 110/60 AC 230/50 AC 230/60 AC</p>	

Note: for electronic connectors type **E-SD**, see tab. K500

14 MOUNTING SUBPLATES

Model	Ports location	GAS Ports A-B-P-T	Ø Counterbore [mm] A-B-P-T	Mass [kg]
BA-202	Ports A, B, P, T underneath;	3/8"	–	1,2
BA-204	Ports P, T underneath; ports A, B on lateral side	3/8"	25,5	1,8
BA-302	Ports A, B, P, T underneath	1/2"	30	1,8

The subplates are supplied with 4 fastening bolts M5x50. Also available are multi-station subplates and modular subplates. For further details see table K280.